

200V Half-Bridge Driver
PRODUCT SUMMARY

- V_{OFFSET} 200 V max.
- $I_{\text{O}+/-}$ 130 mA/270 mA
- V_{OUT} 10 V - 20 V
- $t_{\text{on/off}}$ (typ.) 680 ns/150 ns
- **Deadtime** (typ.) 520 ns

GENERAL DESCRIPTION

The SLM2004S is a high voltage, high speed power MOSFET and IGBT drivers with dependent high- and low-side referenced output channels. Proprietary HVIC and latch immune CMOS technologies enable ruggedized monolithic construction. The logic input is compatible with standard CMOS or LSTTL output, down to 3.3 V logic. The output drivers feature a high pulse current buffer stage designed for minimum driver cross conduction. The floating channel can be used to drive an N-channel power MOSFET or IGBT in the high-side configuration which operates up to 200 V.

FEATURES

- Floating channel designed for bootstrap operation
- Fully operational to +200 V
- Tolerant to negative transient voltage, dV/dt immune
- Gate drive supply range from 10 V to 20 V
- Undervoltage lockout
- 3.3 V, 5 V, and 15 V logic compatible
- Cross-conduction prevention logic
- Matched propagation delay for both channels
- Internal set deadtime
- Shutdown input turns off both channels
- RoHS compliant
- SOIC-8 and PDIP-8 package

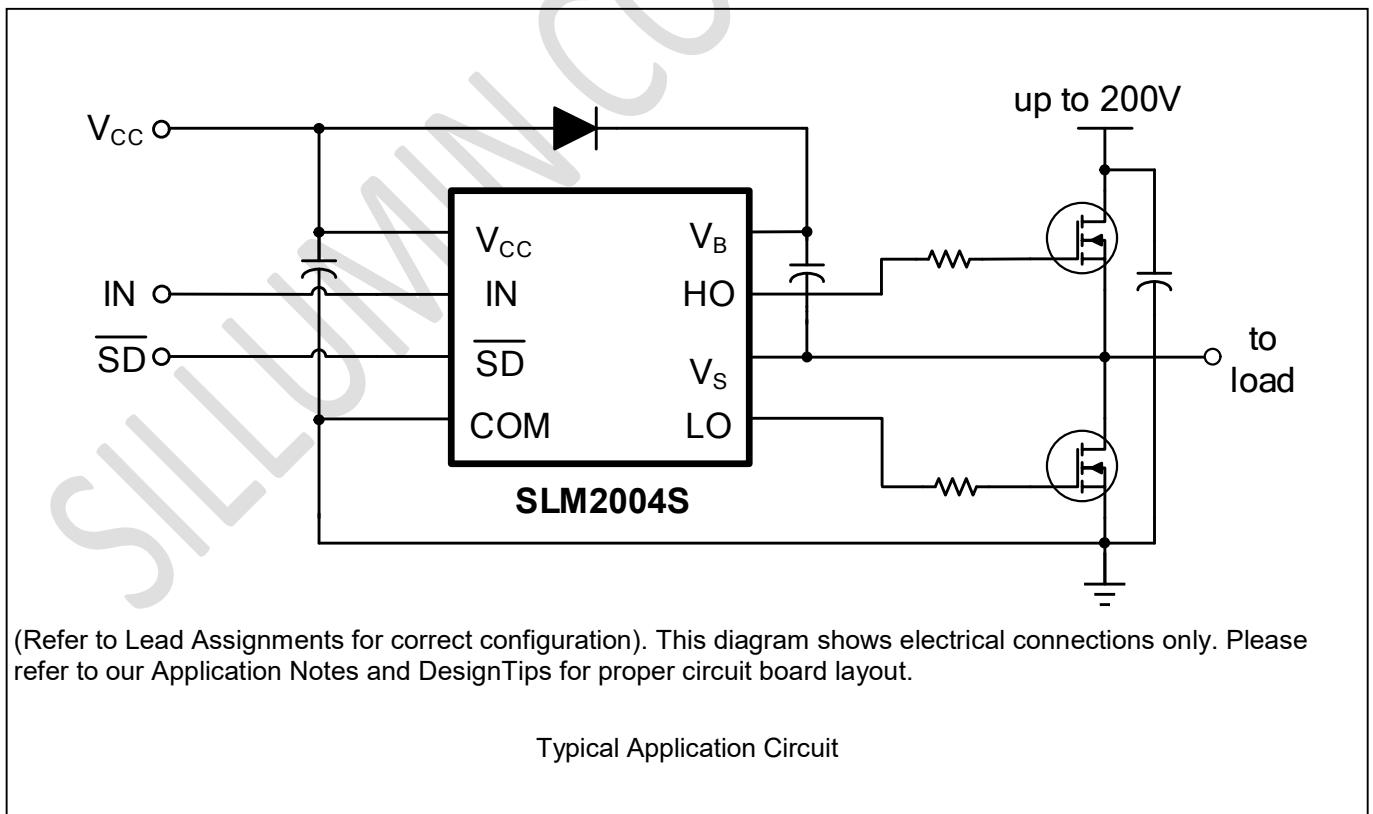
TYPICAL APPLICATION CIRCUIT

PIN CONFIGURATION

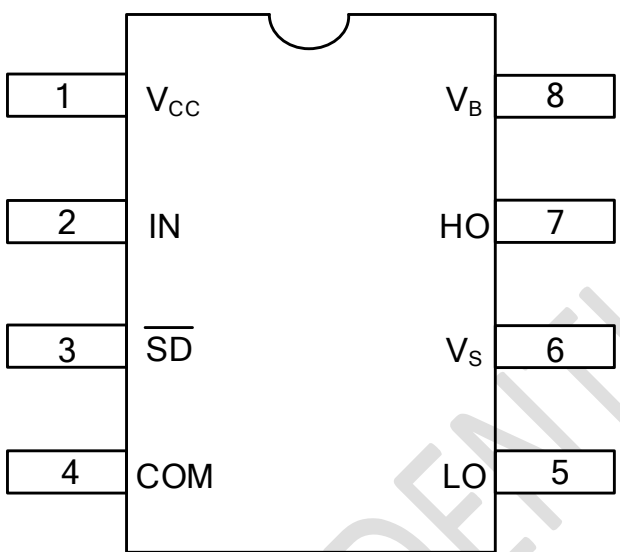
Package	Pin Configuration (Top View)
SOIC-8 and PDIP-8	

PIN DESCRIPTION

No.	Pin	Description
1	V _{CC}	Low-side and logic fixed supply
2	IN	Logic input for high-side and low-side gate driver outputs (HO and LO), in phase with HO
3	$\overline{\text{SD}}$	Logic input for shutdown
4	COM	Low-side return
5	LO	Low-side gate drive output
6	V _s	High-side floating supply return
7	HO	High-side gate drive output
8	V _B	High-side floating supply

ORDERING INFORMATION
Industrial Range: -40°C to +125°C

Order Part No.	Package	QTY
SLM2004SCA-13GTR	SOIC8, Pb-Free	2500/Reel
SLM2004SCA-GT	SOIC8, Pb-Free	100/Tube
SLM2004SDA-GT	PDIP8, Pb-Free	100/Tube

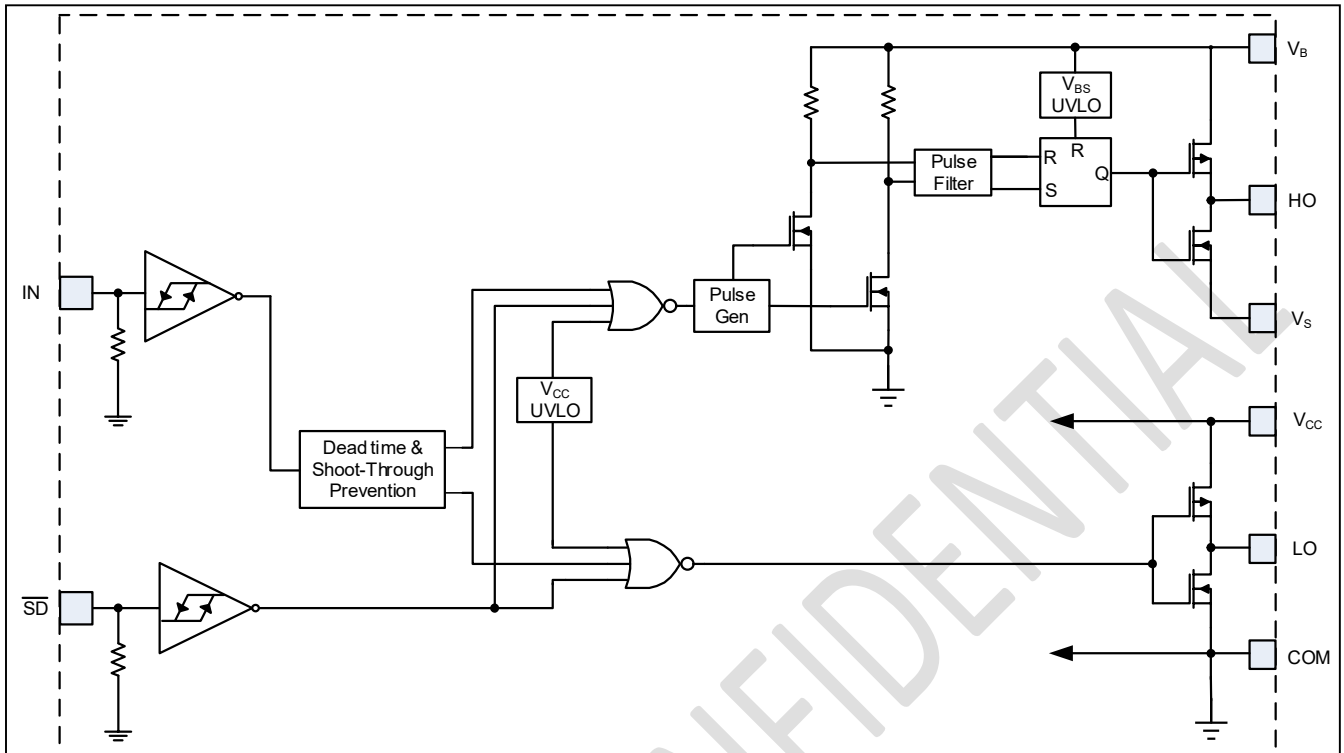
FUNCTIONAL BLOCK DIAGRAM

ABSOLUTE MAXIMUM RATINGS

Symbol	Definition	Min.	Max.	Units	
V _B	High-side floating absolute voltage	-0.3	225	V	
V _S	High-side floating supply offset voltage	V _B - 25	V _B + 0.3		
V _{HO}	High-side floating output voltage	V _S - 0.3	V _B + 0.3		
V _{CC}	Low-side and logic fixed supply voltage	-0.3	25		
V _{LO}	Low-side output voltage	-0.3	V _{CC} + 0.3		
V _{IN}	Logic input voltage (IN & \overline{SD})	-0.3	V _{CC} + 0.3		
dV _S /dt	Allowable offset supply voltage transient	---	50	V/ns	
P _D	Package power dissipation @ T _A ≤ +25°C	PDIP-8	---	1.0	W
		SOIC-8	---	0.625	
R _{thJA}	Thermal resistance, junction to ambient	PDIP-8	---	125	°C/W
		SOIC-8	---	200	
T _J	Junction temperature	---	150	°C	
T _S	Storage temperature	-55	150		
T _L	Lead temperature (soldering, 10 seconds)	---	300		

Note:

Absolute maximum ratings indicate sustained limits beyond which damage to the device may occur. All voltage parameters are absolute voltages referenced to COM. The thermal resistance and power dissipation ratings are measured under board mounted and still air conditions.

RECOMMENDED OPERATING CONDITIONS

Symbol	Definition	Min.	Max.	Units
V _B	High-side floating absolute voltage	V _S + 10	V _S + 20	V
V _S	High-side floating supply offset voltage	Note 1	200	
V _{HO}	High-side floating output voltage	V _S	V _B	
V _{CC}	Low-side and logic fixed supply voltage	10	20	
V _{LO}	Low-side output voltage	0	V _{CC}	
V _{IN}	Logic input voltage (IN & \overline{SD})	0	V _{CC}	
T _A	Ambient temperature	- 40	125	°C

Note:

The input/output logic timing diagram is shown in Fig. 1. For proper operation the device should be used within the recommended conditions. The V_S offset rating is tested with all supplies biased at a 15 V differential.

DYNAMIC ELECTRICAL CHARACTERISTICS
 $V_{BIAS} (V_{CC}, V_{BS}) = 15\text{ V}$, $C_L = 1000\text{ pF}$ and $T_A = 25^\circ\text{C}$ unless otherwise specified.

Symbol	Parameter	Condition	Min.	Typ.	Max.	Unit
t_{on}	Turn-on propagation delay	$V_S = 0\text{ V}$	---	680	820	ns
t_{off}	Turn-off propagation delay	$V_S = 200\text{ V}$	---	150	220	
t_{sd}	Shutdown propagation delay		---	160	220	
t_r	Turn-on rise time		---	70	170	
t_f	Turn-off fall time		---	35	90	
DT	Deadtime, LS turn-off to HS turn-on & HS turn-on to LS turn-off		400	520	650	
MT	Delay matching, HS & LS turn-on/off		---	---	60	

STATIC ELECTRICAL CHARACTERISTICS
 $V_{BIAS} (V_{CC}, V_{BS}) = 15\text{ V}$ and $T_A = 25^\circ\text{C}$ unless otherwise specified. The V_{IN} , V_{TH} , and I_{IN} parameters are referenced to COM. The V_O and I_O parameters are referenced to COM and are applicable to the respective output leads, HO and LO

Symbol	Parameter	Condition	Min.	Typ.	Max.	Unit
V_{IH}	Logic "1" input voltage	$V_{CC} = 10\text{ V to }20\text{ V}$	2.5	---	---	V
V_{IL}	Logic "0" input voltage		---	---	0.8	
VSD, TH+	SD input positive going threshold		2.5	---	---	
VSD, TH-	SD input negative going threshold		---	---	0.8	
V_{OH}	High level output voltage, $V_{BIAS} - V_O$	$I_O = 2\text{ mA}$	---	0.05	0.2	
V_{OL}	Low level output voltage, V_O		---	0.02	0.1	
I_{LK}	Offset supply leakage current	$V_B = V_S = 200\text{ V}$	---	---	50	μA
I_{QBS}	Quiescent V_{BS} supply current	$V_{IN} = 0\text{ V or }5\text{ V}$	---	60	75	
I_{QCC}	Quiescent V_{CC} supply current		---	170	270	
I_{IN+}	Logic "1" input bias current		$V_{IN} = 5\text{ V}$	---	3	
I_{IN-}	Logic "0" input bias current	$V_{IN} = 0\text{ V}$	---	---	5	
V_{CCUV+} V_{BSUV+}	V_{CC} and V_{BS} supply undervoltage positive going threshold		8	8.9	9.8	V
V_{CCUV-} V_{BSUV-}	V_{CC} and V_{BS} supply undervoltage negative going threshold		7.4	8.2	9	
I_{O+}	Output high short circuit pulsed current	$V_O = 0\text{ V}$, $V_{IN} = V_{IH}$ $PW \leq 10\text{ }\mu\text{s}$	130	290		mA
I_{O-}	Output low short circuit pulsed current	$V_O = 15\text{ V}$, $V_{IN} = V_{IL}$ $PW \leq 10\text{ }\mu\text{s}$	270	600		

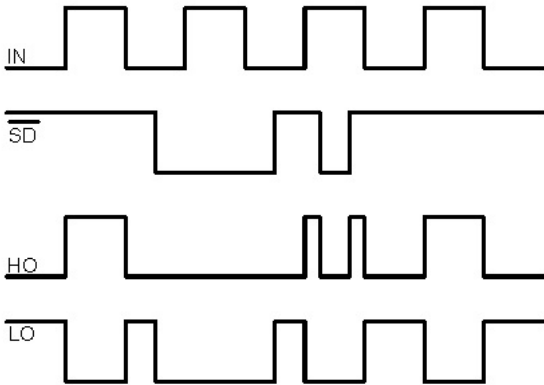
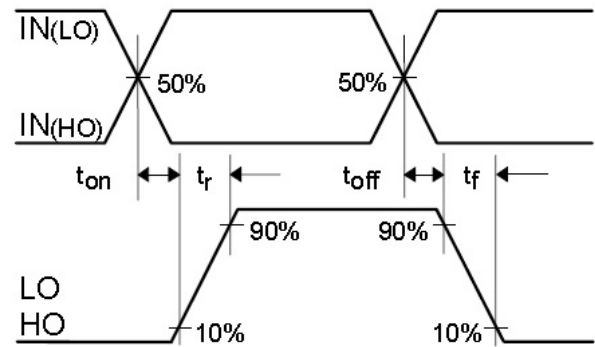
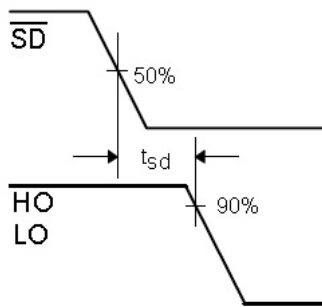
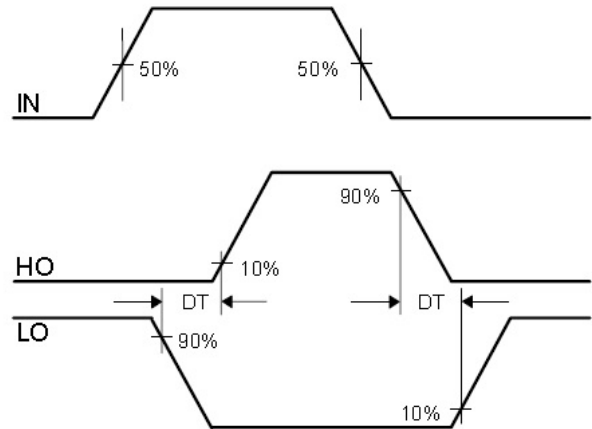
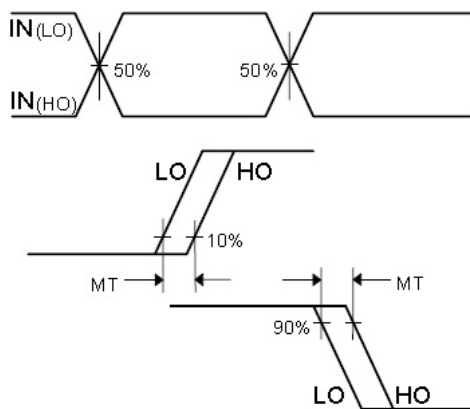
Figure 1. Input/Output Timing Diagram

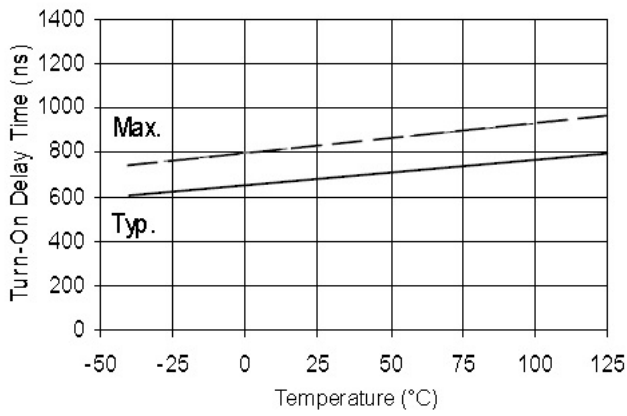
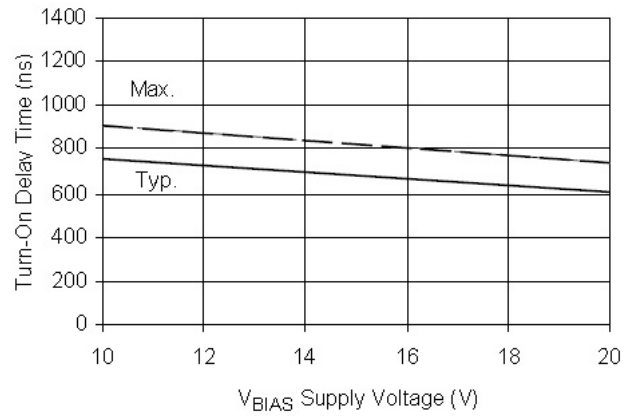
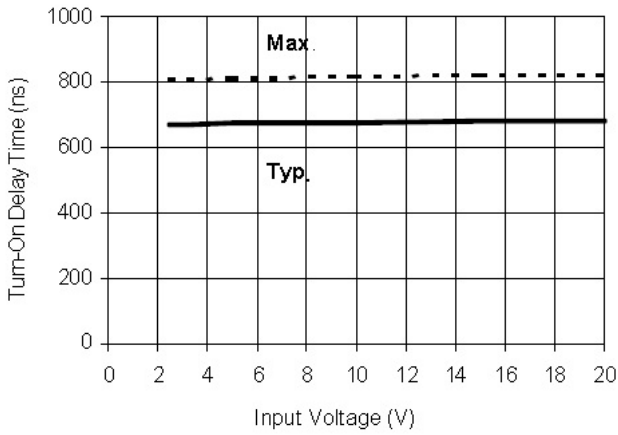
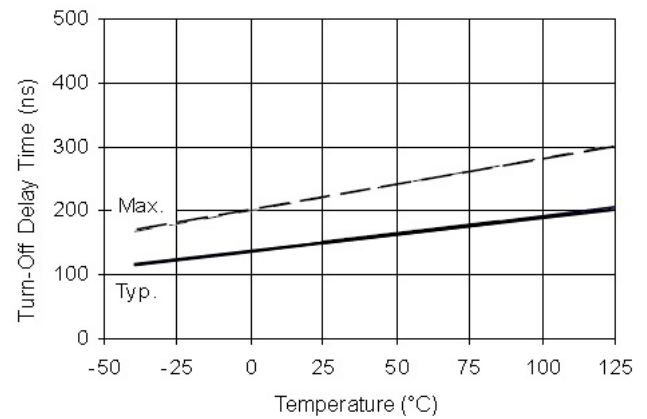
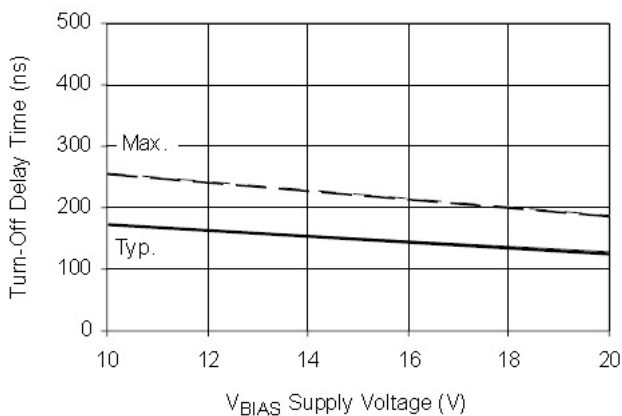
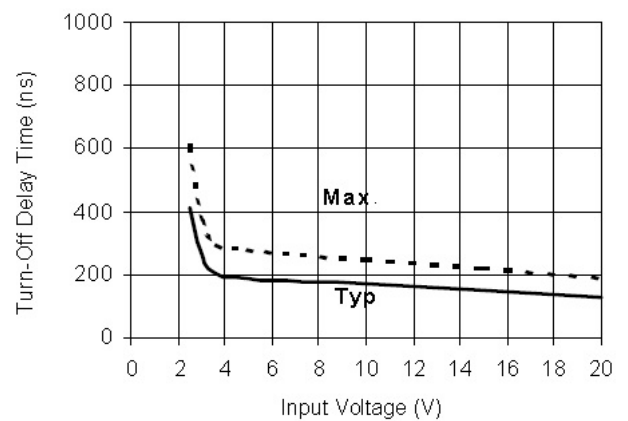
Figure 2. Switching Time Waveform Definitions

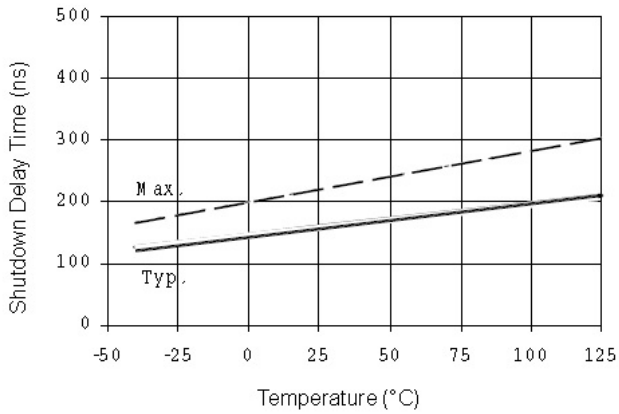
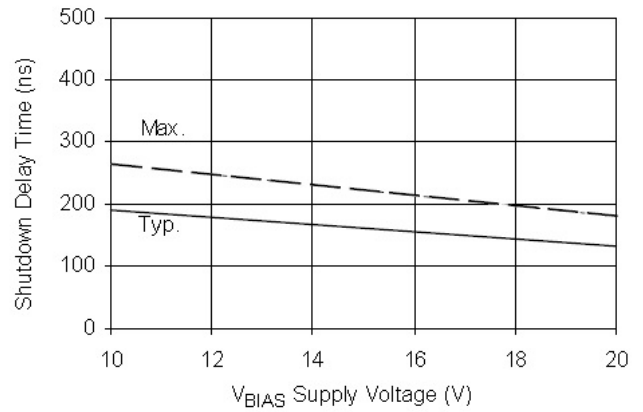
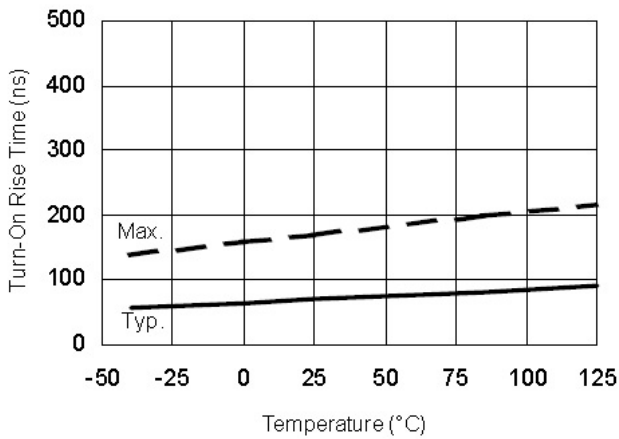
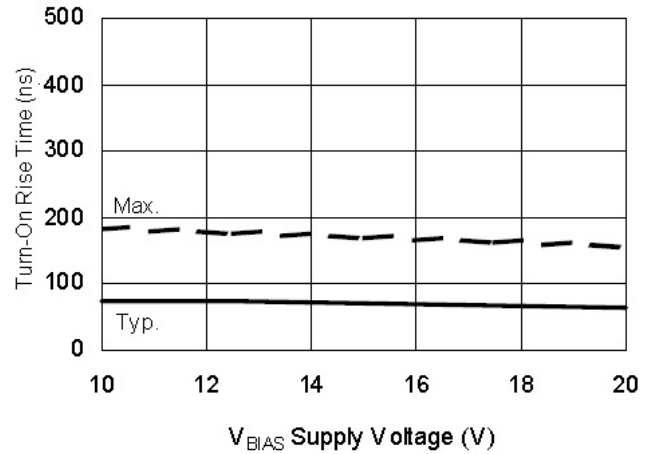
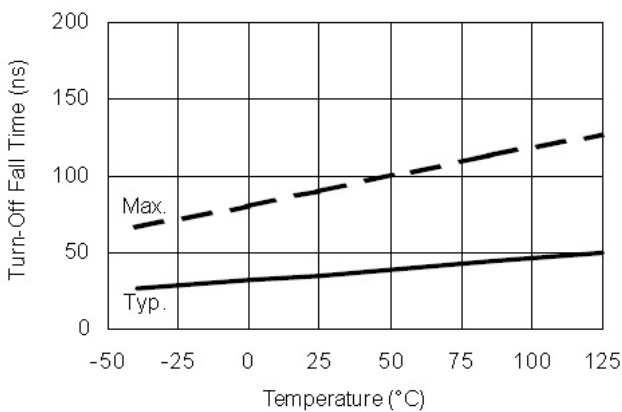
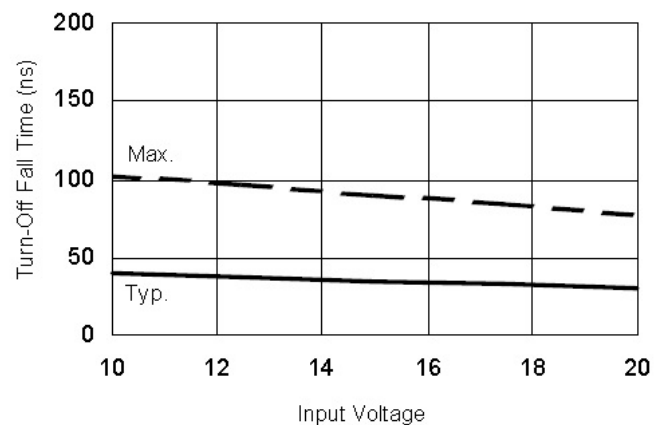
Figure 3. Shutdown Waveform Definitions

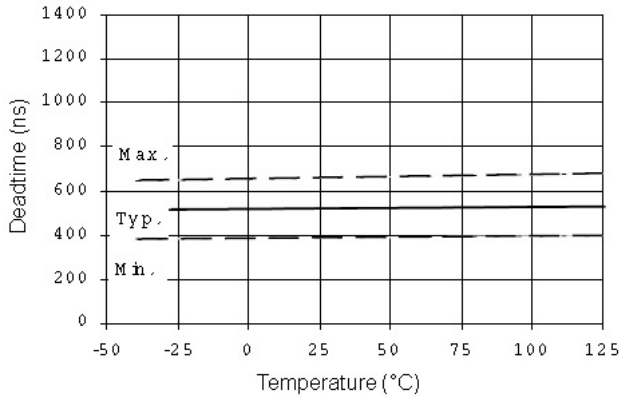
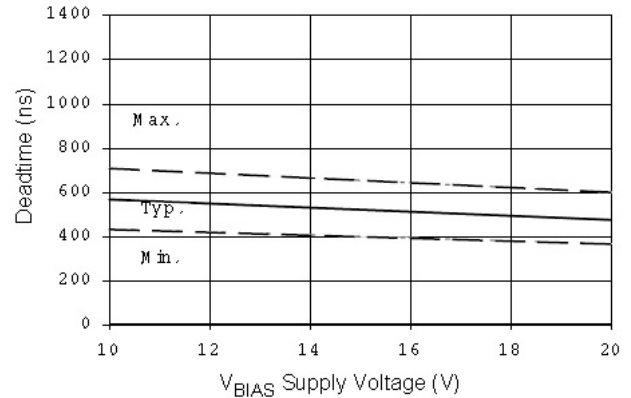
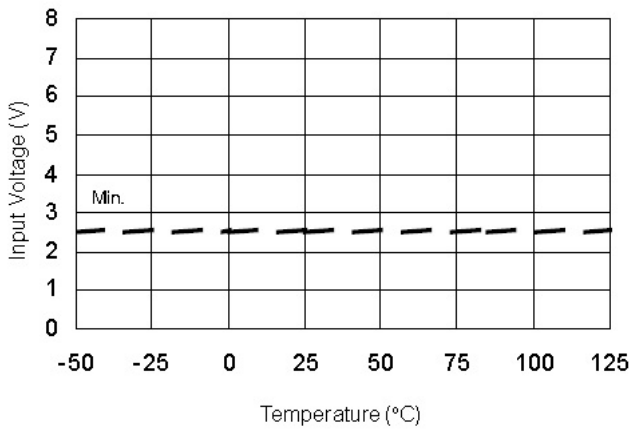
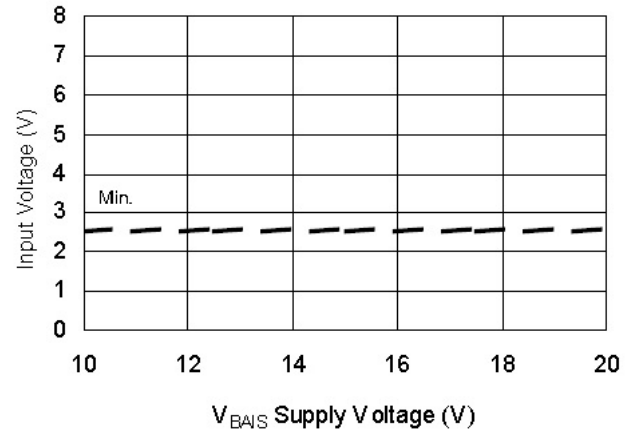
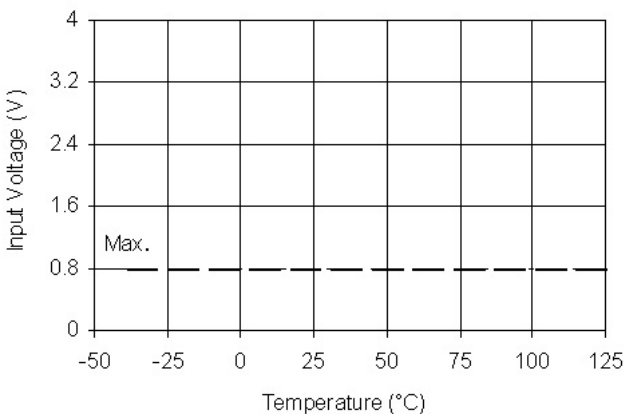
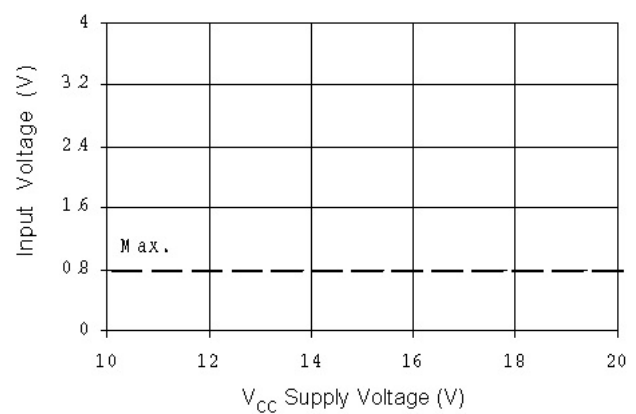
Figure 4. Deadtime Waveform Definitions

Figure 5. Delay Matching Waveform Definitions

Figure 6A. Turn-On Time vs. Temperature

Figure 6B. Turn-On Time vs. Supply Voltage

Figure 6C. Turn-On Time vs. Input Voltage

Figure 7A. Turn-Off Time vs. Temperature

Figure 7B. Turn-Off Time vs. Supply Voltage

Figure 7C. Turn-Off Time vs. Input Voltage

Figure 8A. Shutdown Time vs. Temperature

Figure 8B. Shutdown Time vs. Voltage

Figure 9A. Turn-On Rise Time vs. Temperature

Figure 9B. Turn-On Rise Time vs. Voltage

Figure 10A. Turn-Off Fall Time vs. Temperature

Figure 10B. Turn-Off Fall Time vs. Input Voltage

Figure 11A. Deadtime vs. Temperature

Figure 11B. Deadtime vs. Voltage

Figure 12A. Logic "1" Input Voltage vs. Temperature

Figure 12B. Logic "1" Input Voltage vs. Supply Voltage

Figure 13A. Logic "0" (HO) & Logic "1" (LO) & Active SD Input Voltage vs. Temperature

Figure 13B. Logic "0" (HO) & Logic "1" (LO) & Active SD Input Voltage vs. Voltage

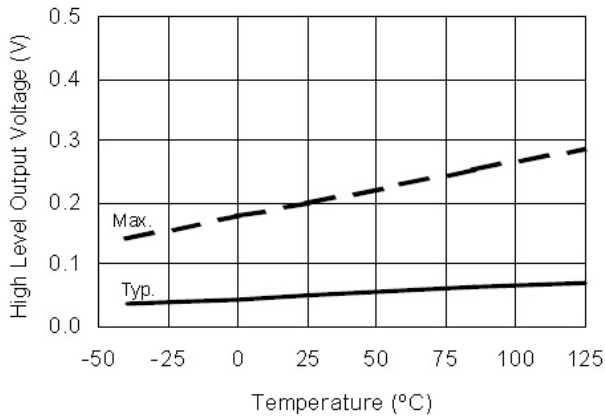

Figure 14A. High Level Output Voltage vs. Temperature

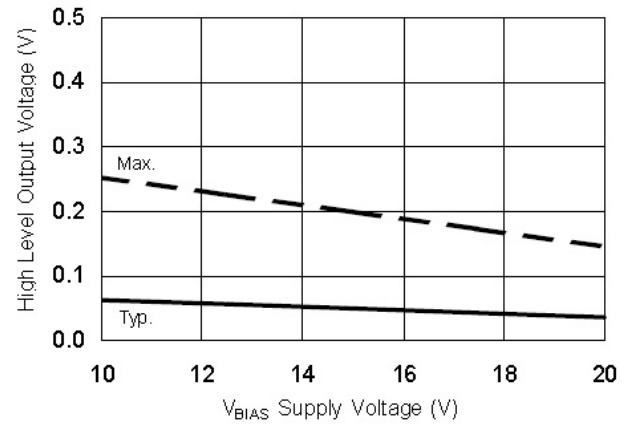

Figure 14B. High Level Output Voltage vs. Supply Voltage

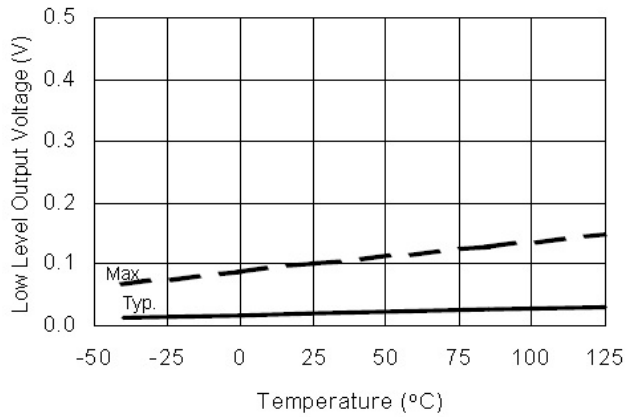

Figure 15A. Low Level Output Voltage vs. Temperature

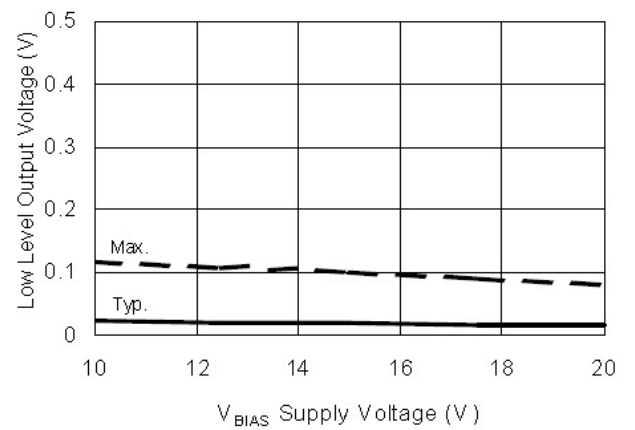

Figure 15B. Low Level Output Voltage vs. Supply Voltage

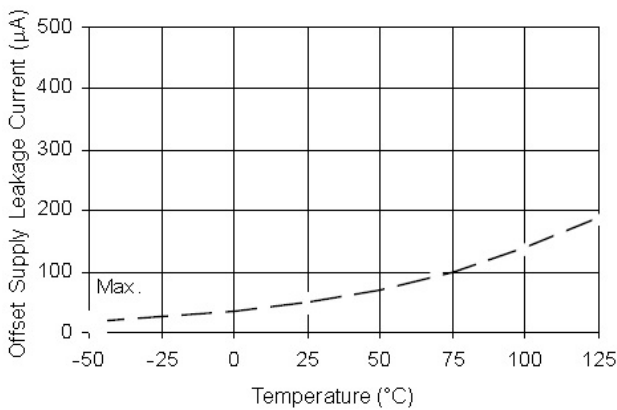

Figure 16A. Offset Supply Current vs. Temperature

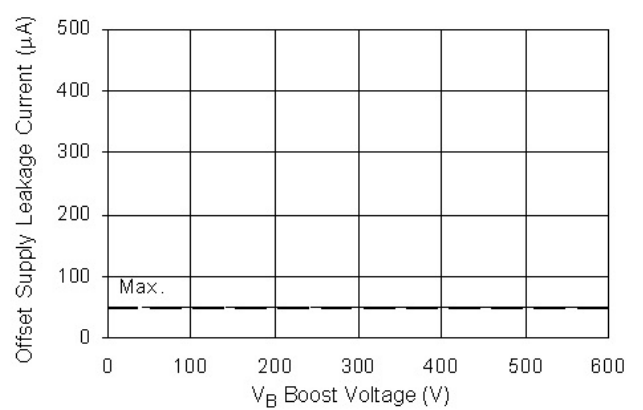

Figure 16B. Offset Supply Current vs. Voltage

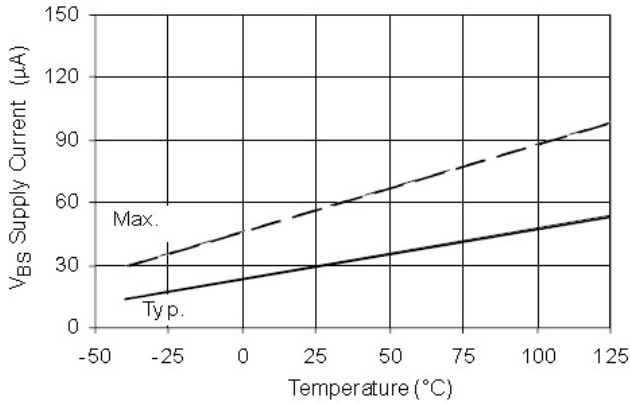

Figure 17A. V_{BS} Supply Current vs. Temperature

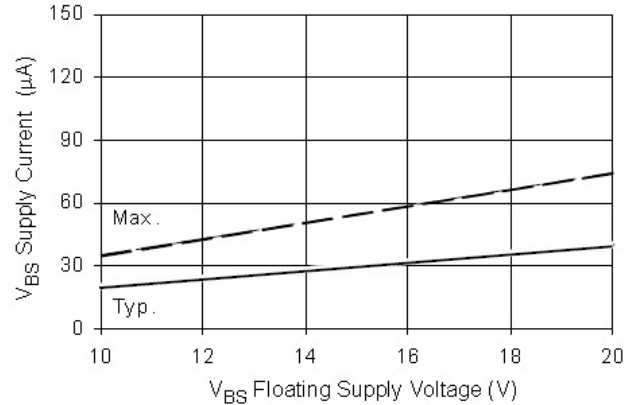

Figure 17B. V_{BS} Supply Current vs. Voltage

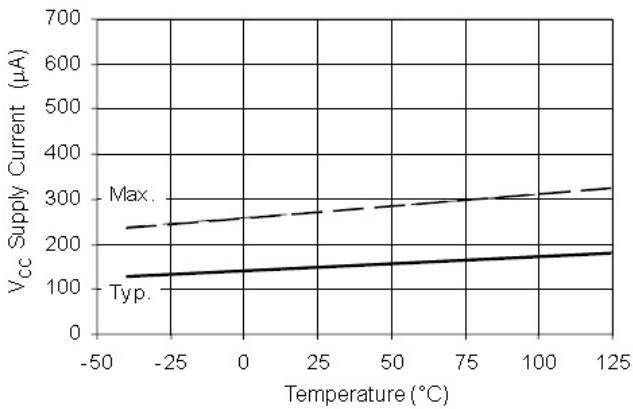

Figure 18A. V_{CC} Supply Current vs. Temperature

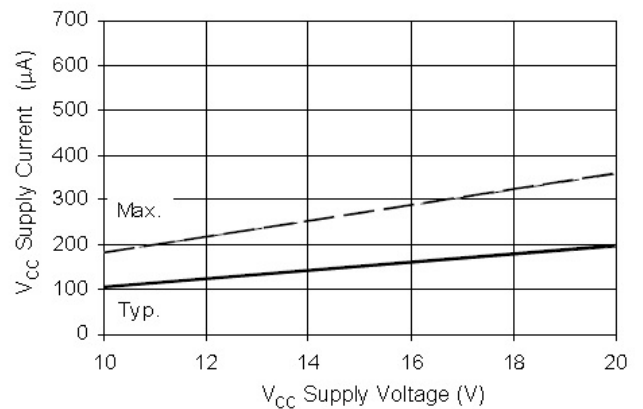

Figure 18B. V_{CC} Supply Current vs. Voltage

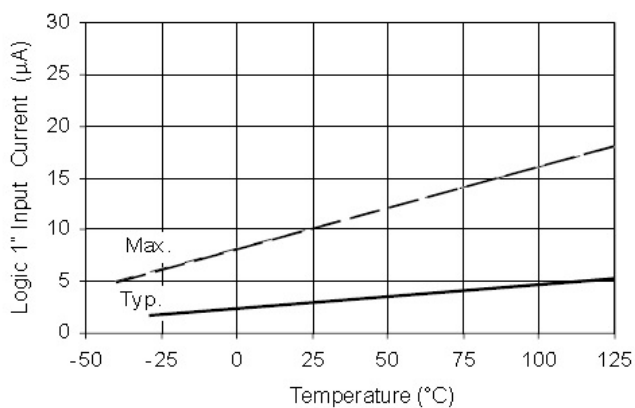

Figure 19A. Logic "1" Input Current vs. Temperature

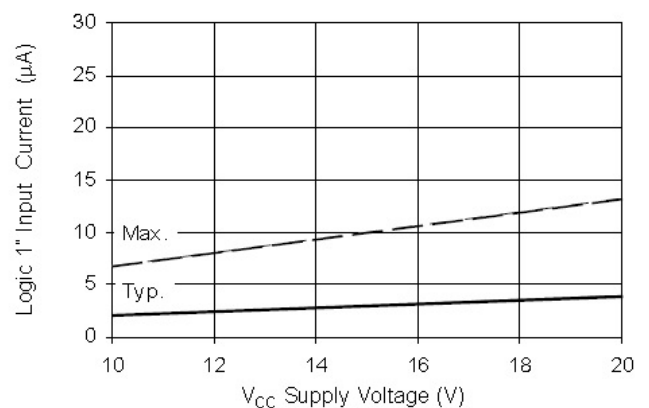

Figure 19B. Logic "1" Input Current vs. Voltage

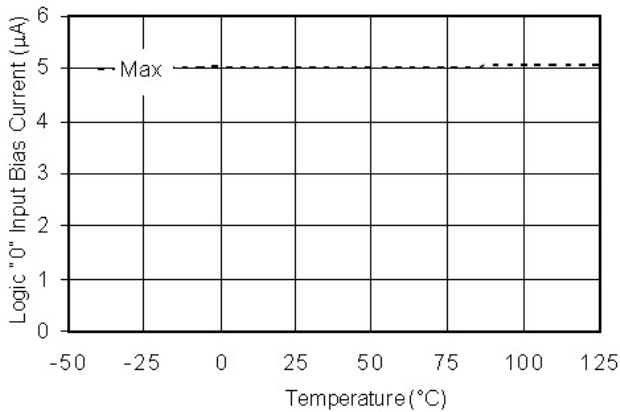

Figure 20A. Logic "0" Input Bias Current vs. Temperature

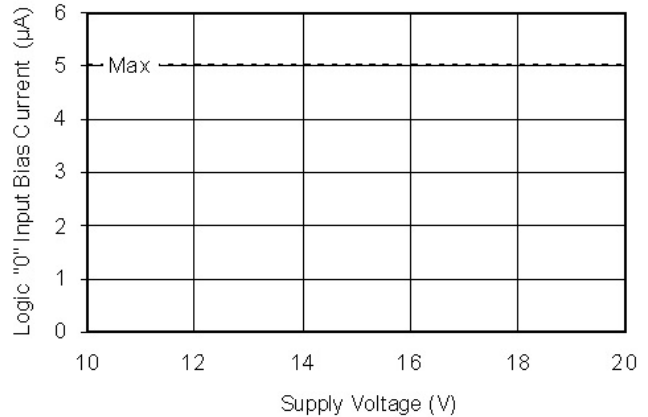

Figure 20B. Logic "0" Input Bias Current vs. Voltage

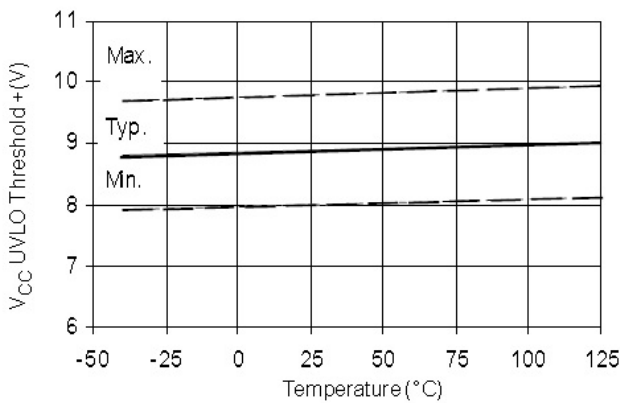

Figure 21A. V_{CC} Undervoltage Threshold(+) vs. Temperature

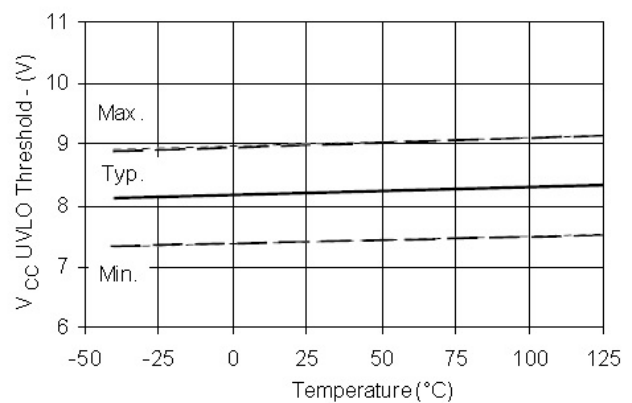

Figure 21B. V_{CC} Undervoltage Threshold(-) vs. Temperature

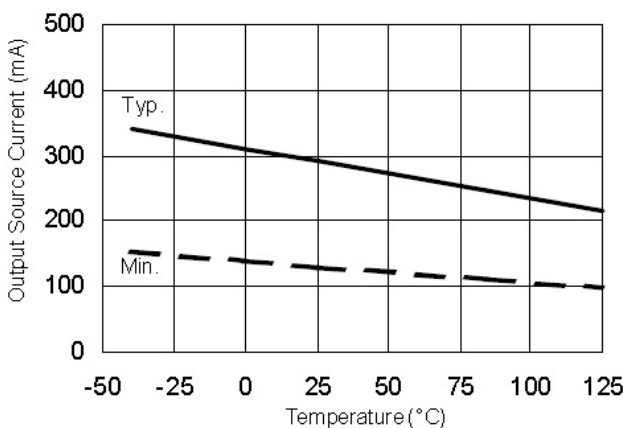

Figure 22A. Output Source Current vs. Temperature

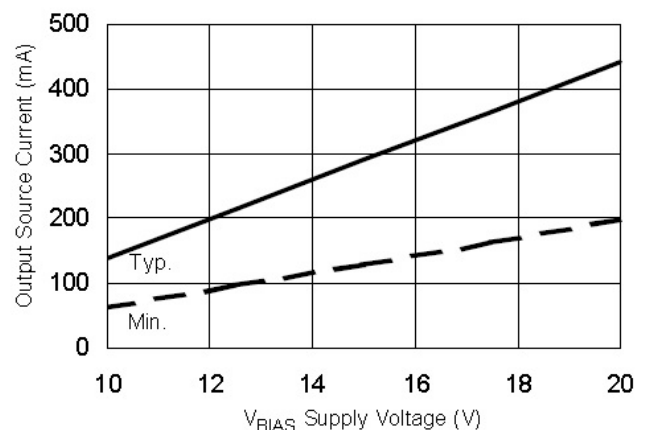

Figure 22B. Output Source Current vs. Voltage

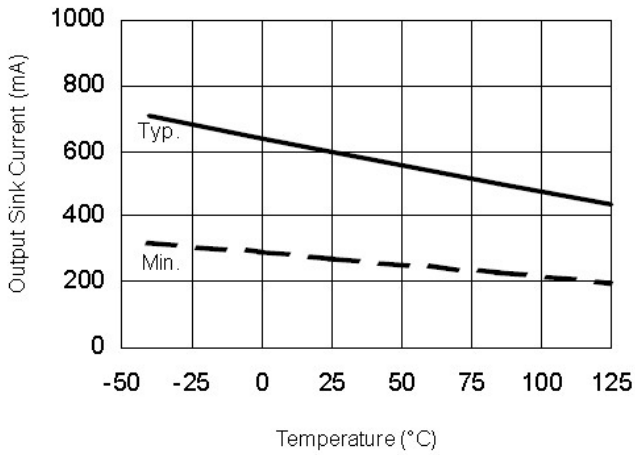

Figure 23A. Output Sink Current vs. Temperature

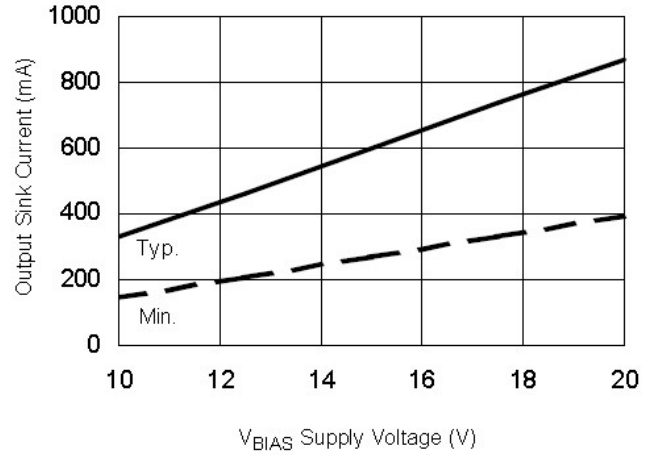

Figure 23B. Output Sink Current vs. Supply Voltage

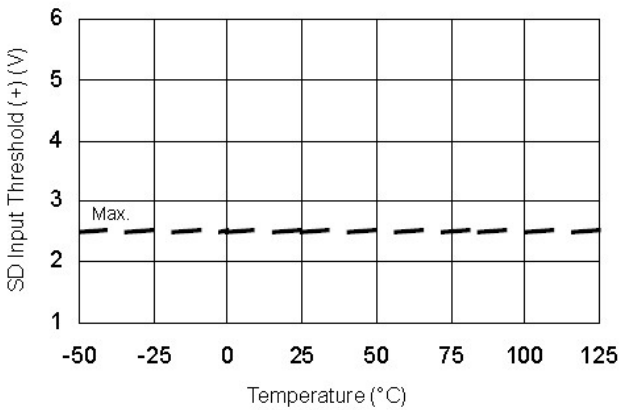

Figure 24A. SD Input Positive Going Threshold (+) vs. Temperature

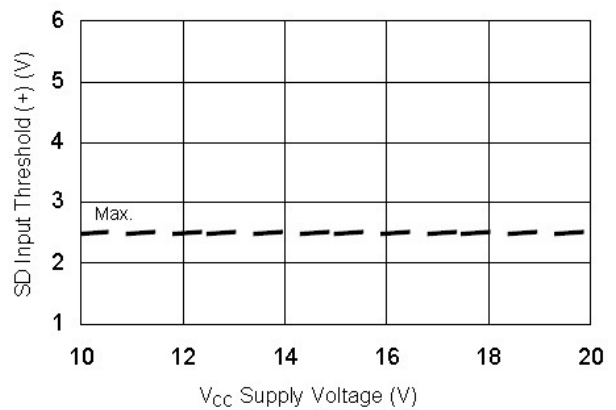
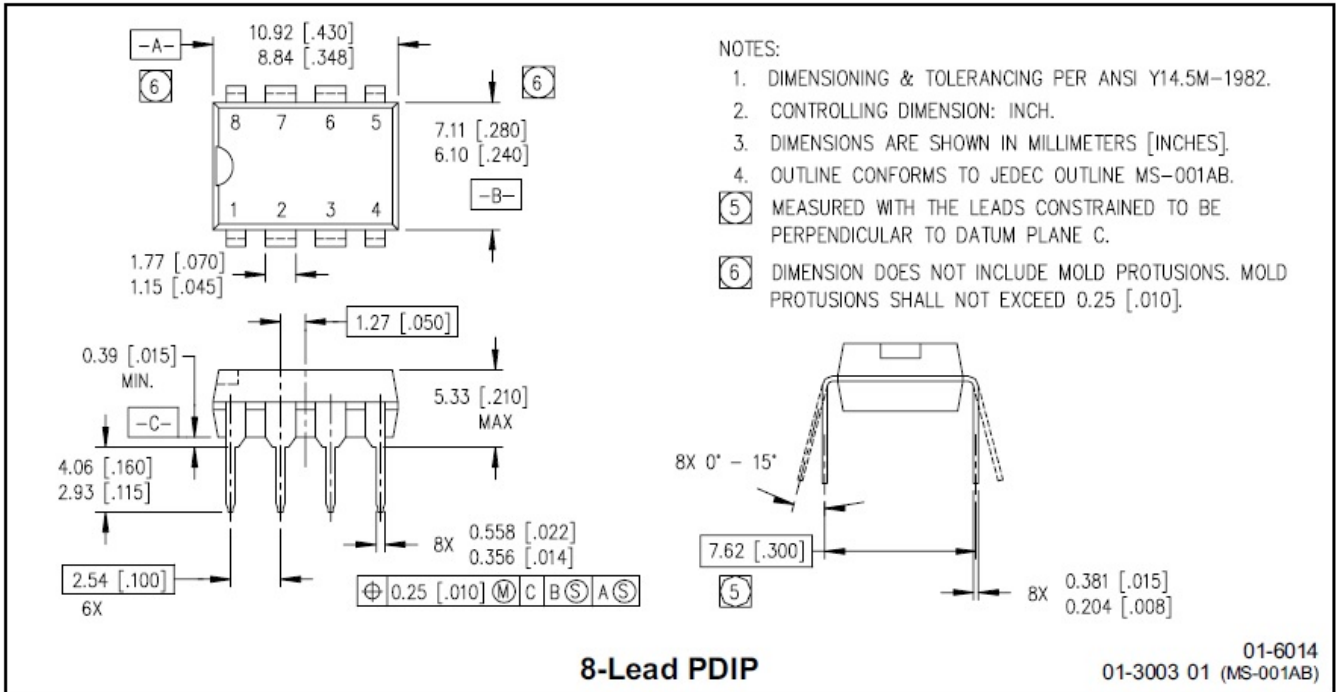
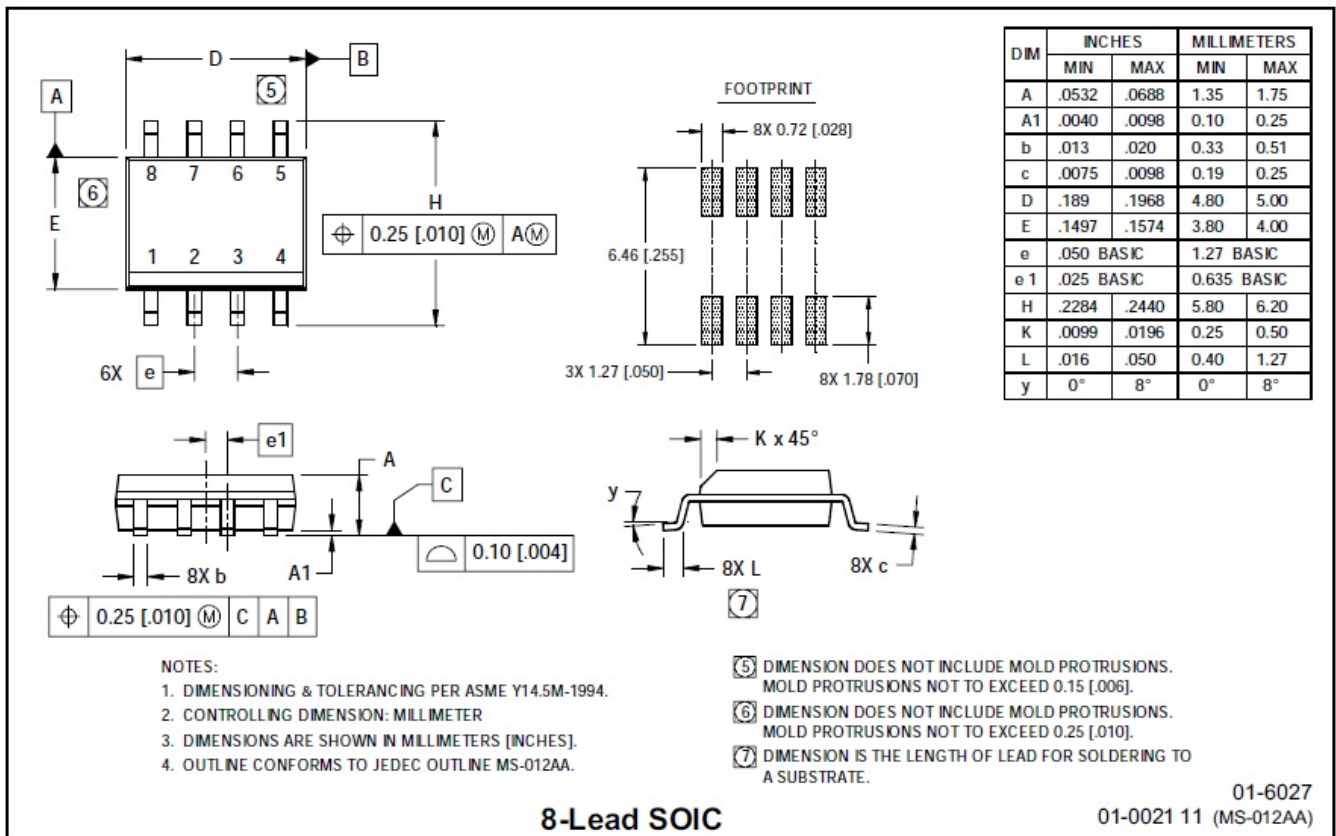
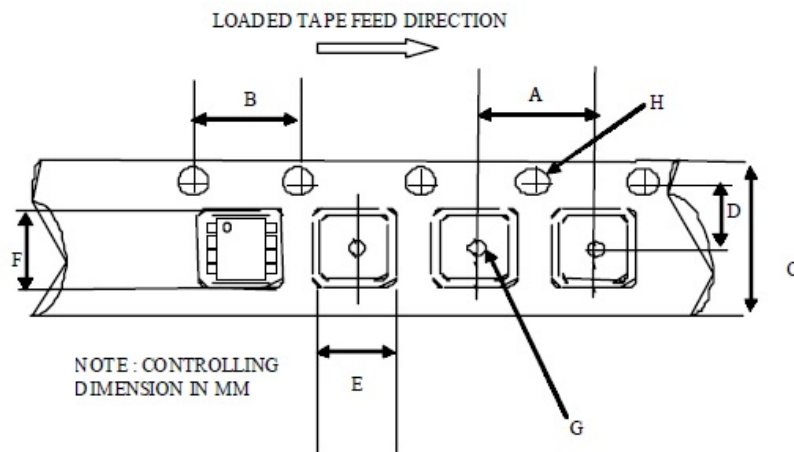
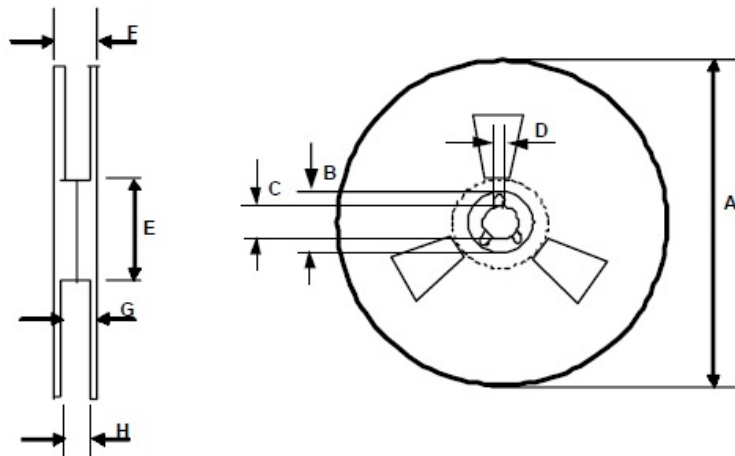

Figure 24B. SD Input Positive Going Threshold (+) vs. Supply Voltage

PACKAGE CASE OUTLINES

8-Lead PDIP

8-Lead SOIC

**Tape & Reel
8-lead SOIC**

CARRIER TAPE DIMENSION FOR 8SOICN

Code	Metric		Imperial	
	Min	Max	Min	Max
A	7.90	8.10	0.311	0.318
B	3.90	4.10	0.153	0.161
C	11.70	12.30	0.46	0.484
D	5.45	5.55	0.214	0.218
E	6.30	6.50	0.248	0.255
F	5.10	5.30	0.200	0.208
G	1.50	n/a	0.059	n/a
H	1.50	1.60	0.059	0.062

REEL DIMENSIONS FOR 8SOICN

Code	Metric		Imperial	
	Min	Max	Min	Max
A	329.60	330.25	12.976	13.001
B	20.95	21.45	0.824	0.844
C	12.80	13.20	0.503	0.519
D	1.95	2.45	0.767	0.096
E	98.00	102.00	3.858	4.015
F	n/a	18.40	n/a	0.724
G	14.50	17.10	0.570	0.673
H	12.40	14.40	0.488	0.566

Revision History

Note: page numbers for previous revisions may differ from page numbers in current version

Page or Item	Subjects (major changes since previous revision)
Rev 1.0 datasheet, 2019-8-27	
Whole document	New company logo released
Page 1	Remove "Fig 1. "